

CMM Styli Catalogue Price Guide

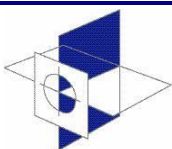

Blank Page

Choosing styli for inspection

In the majority of probing applications to maximise accuracy we recommend that you:-

KEEP STYLI SHORT AND STIFF

The more the stylus bends or deflects, the lower the accuracy. Probing with the minimum stylus length for your application is recommended and where possible the use of one piece styli is suggested. Probing with excessive styli/extension combinations should therefore be avoided.

KEEP THE STYLUS BALL AS LARGE AS POSSIBLE

This will ensure maximum ball/stem clearance whilst providing a greater yet rigid Effective Working Length (EWL). Using larger ruby balls also reduces the effect of surface finish of the component being inspected.

Effective working length (EWL) is the penetration that can be achieved by any ruby ball stylus before its stem fouls against the feature. Generally the larger the ball diameter the greater the EWL (see below).

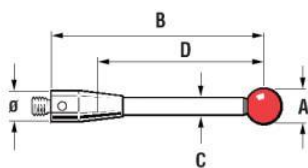

- A Ball diameter
- B Overall length
- C Stem diameter
- D Effective working length
- Ø M2 = 3 mm
- Ø M3 = 4 mm
- Ø M4 = 7 mm
- Ø M5 = 10 mm

EXPLANATION OF STYLI TYPES

RUBY BALL STYLI

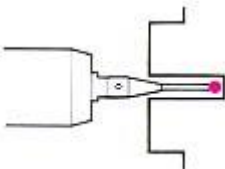

These are suitable for the majority of probing applications. They incorporate highly spherical industrial ruby balls. Ruby is an extremely hard ceramic material and hence wear of stylus balls is minimised. It is also of low density keeping tip mass to a minimum which avoids unwanted probe triggers caused by machine motion or vibration. Ruby balls are available mounted on a variety of materials including non-magnetic stainless steel, ceramic and carbide, to maintain stiffness over the total range of styli.

STAR STYLI*

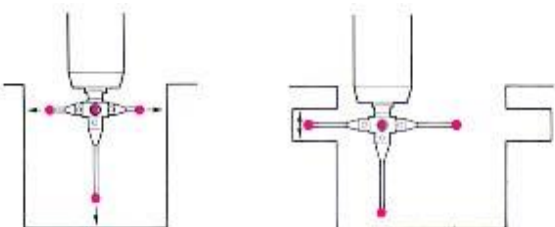

These can be used to inspect a variety of different features.

Using star styli to inspect the extreme points of internal features such as the sides or grooves in a bore, minimises the need to move the probe, due to their multi-tip probing capability.

Each tip on a star stylus requires datuming in the same manner as a single ball stylus.

POINTER STYLI *

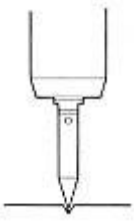

These should not be used for conventional XY Probing. Designed for the measurement of thread forms, specific points and scribed lines (to lower accuracy). The use of radius end pointer styli allows more accurate datuming and probing of features, and can also be used to inspect the location of very small holes.

CERAMIC HOLLOW BALL STYLI

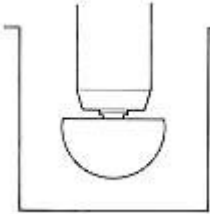

These are ideal for probing deep features and bores in X, Y and Z directions with the need to datum only one ball. In addition, the effects of very rough surfaces can be averaged out by probing with such a large diameter ball.

DISC STYLI *

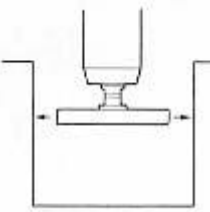

These 'thin sections' of a large sphere are usually used to probe undercuts and grooves. Although probing with the "spherical edge" of a simple disc is effectively the same as probing on or about the equator of a large stylus ball, only a small area of this ball surface is available for contact. Hence thinner discs require careful angular alignment to ensure correct contact of the disc surface with the feature being probed.

A simple disc requires datuming on only one diameter (usually in a ring gauge) but limits effective probing to only X and Y directions.

Adding a radius end roller allows you to datum and hence probe in the Z direction, providing the centre of the 'radius end roller' extends beyond the diameter of the probe.

The radius end roller can be datumed on a sphere or a slip gauge. Rotating and locking the disc about its centre axis allows the 'radius end roller' to be positioned to suit the application.

Disc may also have an M2 threaded centre to allow the fixing of a centre stylus, giving the additional flexibility of probing the bottom of deep bores (where access for the disc may be limited).

CYLINDER STYLI

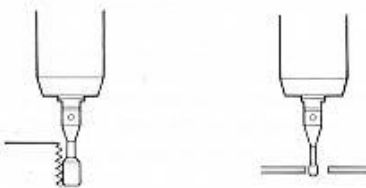

These are used for probing holes in thin sheet material, probing various threaded features and locating the centres of tapped holes.



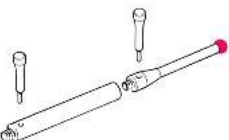

Ball ended cylinder styli allow full datuming and probing in X, Y and Z directions thus allowing surface inspection to be carried out.

STYLUS EXTENSIONS



These provide added probing penetration by extending the stylus away from the probe. However, using stylus extensions can reduce accuracy due to loss of rigidity.

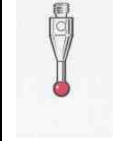
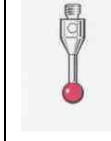
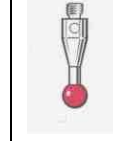
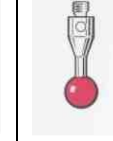
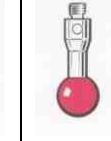
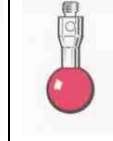

Ruby Ball Styli (stainless steel stems) 10mm Range ~ M2 Thread

Part No.	A-5000 -7806	A-5000 -7802	A-5000 -7807	A-5000 -7803	A-5000 -3604	A-5000 -4154	A-5000 -4155	A-5000 -4156	A-5000 -4158
A Ball Dia	1.0	1.5	2.0	2.5	3.0	4.0	5.0	6.0	8.0
B Length	10.0	10.0	10.0	10.0	10.0	10.0	10.0	10.0	11.0
C Stem Dia	0.7	0.7	1.0	1.0	1.5	1.5	2.5	2.5	2.5
D EWL	4.5	4.5	6.0	6.0	7.5	10.0	10.0	10.0	11.0
Weight	0.3	0.3	0.3	0.3	0.4	0.4	0.7	0.9	1.5
10mm range									
Price excl VAT	£18.20	£14.66	£12.73	£13.48	£14.75	£15.52	£20.34	£22.35	£41.61

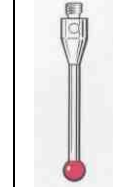
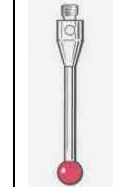
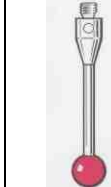
Ruby Ball Styli (stainless steel stems) 20mm Range ~ M2 Thread

Part No.	A-5000 -3603	A-5000 -7804	A-5000 -4160	A-5000 -4161
A Ball Dia	2.0	2.5	3.0	4.0
B Length	20.0	20.0	20.0	20.0
C Stem Dia	1.4	1.4	1.5	1.5
D EWL	14.0	14.0	17.5	20.0
Weight	0.4	0.4	0.5	0.6
20mm range				
Price excl VAT	£14.30	£14.70	£15.44	£16.09

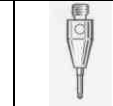
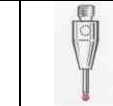
Ruby Ball Styli (tungsten carbide stems) 10mm Range ~ M2 Thread

Part No.	A-5000 -7800	A-5000 -7805	A-5000 -7801	A-5003 -1325
A Ball Dia	0.3	0.5	0.7	1.0
B Length	10.0	10.0	10.0	10.0
C Stem Dia	0.2	0.4	0.5	0.7
D EWL	2.0	3.0	4.0	2.0
Weight	0.3	0.3	0.3	0.3
10mm range				
Price excl VAT	£76.00	£75.94	£63.41	£40.00

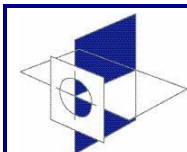

STATUS
Metrology





Status Metrology
Lenton Street
Sandiacre
Nottingham
NG10 5DX

Tel 0115 939 2228
Fax 0115 939 3355





sales@statusmetrology.com
www.statusmetrology.com

Page 5 of 17

Ruby Ball Styli (tungsten carbide stems) 20mm Range ~ M2 Thread

Part No.	A-5003 -1345	A-5003 -0577	A-5000 -7808	A-5003 -0033	A-5003 -0034
A Ball Dia	0.5	0.7	1.0	1.0	1.5
B Length	20.0	20.0	20.0	20.0	20.0
C Stem Dia	0.3	0.5	0.7	0.8	1.0
D EWL	7.0	12.0	7.0	12.5	12.5
Weight	0.48	0.32	0.5	0.41	0.5
20mm range					
Price excl VAT	£80.00	£67.0	£30.39	£37.35	£37.35

Ruby Ball Styli (tungsten carbide stems) 20mm Range ~ M2 Thread cont'd

Part No.	A-5003 -3822	A-5003 -1896	A-5003 -0938	A-5003 -1029	A-5003 -0046
A Ball Dia	2.0	2.5	3.0	4.0	5.0
B Length	20.0	20.0	20.0	20.0	20.0
C Stem Dia	1.0	1.0	1.5	2.0	2.5
D EWL	12.0	15.5	20.0	22.0	20.0
Weight	0.48	0.5	0.77	1.24	1.98
20mm range					
Price excl VAT	£37.35	£37.35	£40.85	£40.85	£40.85

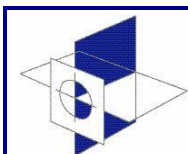

STATUS
Metrology

Status Metrology
Lenton Street
Sandiacre
Nottingham
NG10 5DX

Tel 0115 939 2228
Fax 0115 939 3355

sales@statusmetrology.com
www.statusmetrology.com

Ruby Ball Styli (tungsten carbide stems) 30mm Range ~ M2 Thread

Part No.	A-5000 -8663	A-5003 -0035	A-5003 -0036	A-5003 -0038	A-5003 -0040	A-5003 -0043	A-5003 -0047
A Ball Dia	1.0	1.5	2.0	2.5	3.0	4.0	5.0
B Length	27.0	30.0	30.0	30.0	30.0	30.0	30.0
C Stem Dia	0.7	1.0	1.5	2.0	2.0	2.0	2.5
D EWL	20.5	22.5	22.5	25.0	25.0	30.0	30.0
Weight	0.40	0.58	0.99	1.48	1.49	1.57	2.57
30mm range							
Price excl VAT	£49.03	£40.85	£37.35	£37.35	£40.85	£40.85	£40.85

Ruby Ball Styli (ceramic stems) 30mm Range ~ M2 Thread cont'd

Part No.	A-5003 -4177	A-5003 -1370	A-5003 -4779	A-5003 -4780
A Ball Dia	3.0	4.0	5.0	6.0
B Length	30.0	30.0	30.0	30.0
C Stem Dia	2.0	2.0	2.5	2.5
D EWL	27.5	30.0	30.0	30.0
Weight	0.44	0.68	0.93	1.11
30mm range				
Price excl VAT	£50.00	£55.00	£45.00	£47.86

Ruby Ball Styli (carbon fibre stems) 30mm Range ~ M2 Thread cont'd

Part No.	A-5003 -4241	A-5003 -4781	A-5003 -4782
A Ball Dia	4.0	5.0	6.0
B Length	30.0	30.0	30.0
C Stem Dia	2.0	3.0	3.0
D EWL	30.0	30.0	30.0
Weight	0.57	0.79	0.96
30mm range			
Price excl VAT	£52.00	£54.00	£57.00

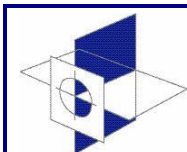









STATUS
Metrology

Status Metrology
Lenton Street
Sandiacre
Nottingham
NG10 5DX

Tel 0115 939 2228
Fax 0115 939 3355
sales@statusmetrology.com
www.statusmetrology.com

Ruby Ball Styli (tungsten carbide stems) 40mm & 50mm Range ~ M2 Thread

Part No.	A-5003 -0037	A-5003 -0039	A-5003 -0041	A-5003 -0044	A-5003 -0048	A-5003 -0042	A-5003 -0045	A-5003 -0049
A Ball Dia	2.0	2.5	3.0	4.0	5.0	3.0	4.0	5.0
B Length	40.0	40.0	40.0	40.0	40.0	50.0	50.0	50.0
C Stem Dia	1.5	2.0	2.0	2.0	2.5	2.0	2.0	2.5
D EWL	32.5	32.5	37.0	40.0	40.0	47.0	50.0	50.0
Weight	1.29	1.95	1.97	2.04	3.17	2.44	2.52	3.75
40mm range & 50mm range								
Price excl VAT	£40.85	£40.85	£43.78	£43.78	£43.78	£43.78	£43.78	£43.78

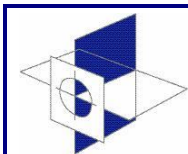

STATUS

Metrology

Status Metrology
Lenton Street
Sandiacre
Nottingham
NG10 5DX

Tel 0115 939 2228
Fax 0115 939 3355
sales@statusmetrology.com
www.statusmetrology.com

Ruby Ball Styli (ceramic stems) 50mm Range ~ M2 Thread cont'd

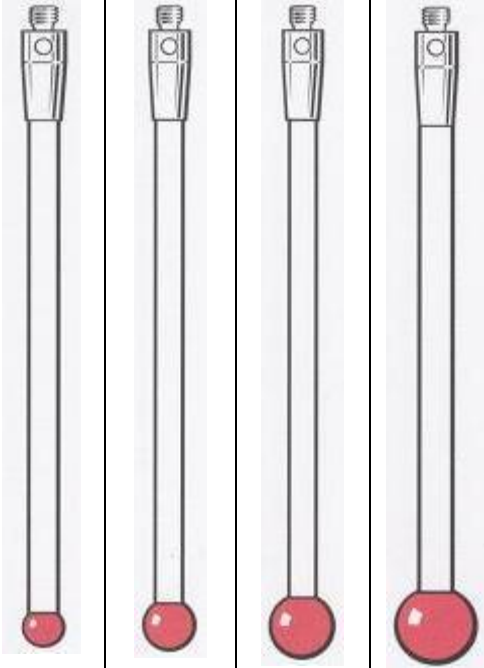
Part No.	A-5003 -0064	A-5003 -0065	A-5003 -0066	A-5003 -0470
A Ball Dia	3.0	4.0	5.0	6.0
B Length	50.0	50.0	50.0	50.0
C Stem Dia	2.0	2.0	2.5	2.5
D EWL	47.0	50.0	50.0	50.0
Weight	0.83	0.91	1.31	1.49
50mm range				
Price excl VAT	£47.86	£47.86	£47.86	£45.00

Ruby Ball Styli (carbon fibre stems) 50mm Range ~ M2 Thread cont'd

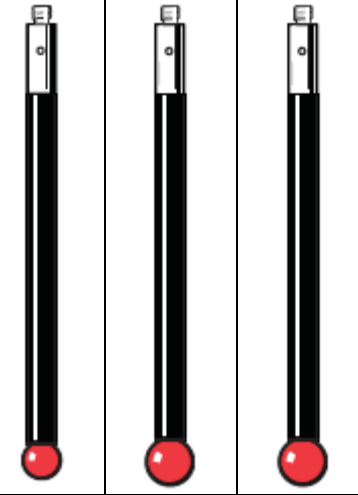
Part No.	A-5003 -2285	A-5003 -2286	A-5003 -2287
A Ball Dia	4.0	5.0	6.0
B Length	50.0	50.0	50.0
C Stem Dia	3.0	3.0	3.0
D EWL	50.0	50.0	50.0
Weight	1.00	1.10	1.20
50mm range			
Price excl VAT	£57.84	£59.98	£62.12

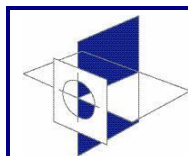

STATUS
Metrology

Status Metrology
Lenton Street
Sandiacre
Nottingham
NG10 5DX

Tel 0115 939 2228
Fax 0115 939 3355
sales@statusmetrology.com
www.statusmetrology.com

Ruby Ball Styli (carbon fibre stems) 75mm Range ~ M2 Thread cont'd

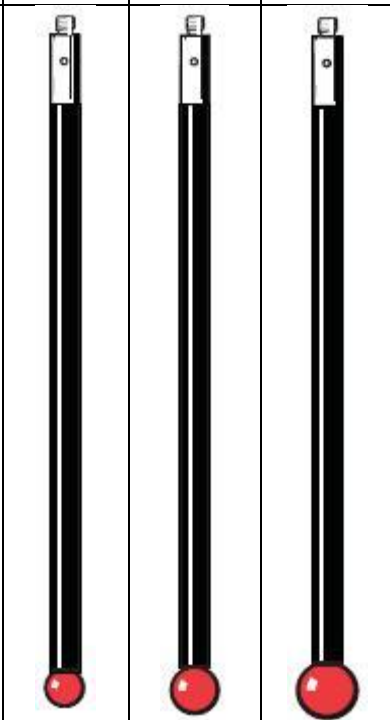
Part No.	A-5003 -4784	A-5003 -4785	A-5003 -4786
A Ball Dia	4.0	5.0	6.0
B Length	75.0	75.0	75.0
C Stem Dia	3.0	3.0	3.0
D EWL	75.0	75.0	75.0
Weight	1.15	1.27	1.45
75mm range			
Price excl VAT	£70.50	£75.00	£79.50





STATUS
Metrology

Status Metrology
Lenton Street
Sandiacre
Nottingham
NG10 5DX

Tel 0115 939 2228
Fax 0115 939 3355
sales@statusmetrology.com
www.statusmetrology.com

Ruby Ball Styli (carbon fibre stems) 100mm Range ~ M2 Thread cont'd

Part No.	A-5003 -2289	A-5003 -2290	A-5003 -2291
A Ball Dia	4.0	5.0	6.0
B Length	100.0	100.0	100.0
C Stem Dia	3.0	3.0	3.0
D EWL	100.0	100.0	100.0
Weight	1.50	1.59	1.78
100mm range			
Price excl VAT	£80.50	£85.00	£89.50







STATUS
Metrology

Status Metrology
Lenton Street
Sandiacre
Nottingham
NG10 5DX

Tel 0115 939 2228
Fax 0115 939 3355
sales@statusmetrology.com
www.statusmetrology.com

Stylus Extensions (carbon fibre stems) ~ M2 Thread cont'd

Part No.	A-5003 -2280	A-5003 -2281	A-5003 -2282	A-5003 -2283
Length	40.0	50.0	70.0	90.0
Stem Dia	3.0	3.0	3.0	3.0
Outer Dia	3.5	3.5	3.5	3.5
Weight	0.9	1.0	1.3	1.5
75 - 100mm range				
Price excl VAT	£53.54	£55.69	£57.84	£59.98









STATUS
Metrology





Status Metrology
Lenton Street
Sandiacre
Nottingham
NG10 5DX

Tel 0115 939 2228
Fax 0115 939 3355
sales@statusmetrology.com
www.statusmetrology.com







Cylinder Ball Styli (stainless steel stems) ~ M2 Thread

Part No.	A-5004 -7589	A-5004 -7590	A-5000 -8876	A-5000 -8877	A-5000 -7812	A-5000 -0073
A Ball Dia	1.5	3.0	1.0	1.5	2.0	4.0
B Length	11.0	13.0	15.0	15.0	20.0	20.0
C Stem Dia	1.0	1.5	NA	NA	1.6	2.0
D EWL	1.5	3.8	8.0	8.0	7.2	10.0
Weight	0.3	0.6	0.3	0.3	0.5	0.9
10mm range						
Price excl VAT	£11.18	£11.18	£158.27	£138.93	£104.34	£127.26

Stylus extensions (stainless steel stems) ~ M2 Thread

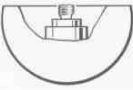
Part No.	A-5004 -7610	A-5004 -7585	A-5004 -7586	A-5004 -7591	A-5004 -7611
Length	5.0	10.0	20.0	30.0	40.0
Stem Dia	3.0	3.0	3.0	3.0	3.0
Weight	0.2	0.4	0.9	1.4	1.8
					
Price excl VAT	£6.24	£7.30	£7.99	£9.04	£9.80

Special purpose styli ~ M2 Thread

Part No.	A-5004 -7588 Silver steel	A-5000 -7813 Tungsten carbide	A-5000 -3614 Ceramic	A-5000 -7534 M2 Knuckle	A-5004 -7593 M2/M3 adaptor	A-5004 -7592 M3/M2 adaptor
Length mm	15.0	10.0	11.0	8.0	7.0	5.0
Ball dia mm	NA	NA	18.0	NA	NA	NA
End feature mm	Flat Rad 0.05	Flat Rad 0.05	NA	NA	NA	NA
Weight	0.7	0.7	3.3	1.6	0.6	1.5
Angles	30 inclusive	30 inclusive	NA	NA		
						
Price excl VAT	£14.51	£50.80	£160.03	£33.63	£6.86	£6.00







STATUS
Metrology

Status Metrology
Lenton Street
Sandiacre
Nottingham
NG10 5DX

Tel 0115 939 2228
Fax 0115 939 3355
sales@statusmetrology.com
www.statusmetrology.com

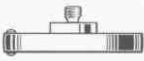

Stylus extensions (stainless steel stems) ~ M2 Thread

Part No.	A-5000 -3611	A-5000 -4187	A-5000 -7809	A-5000 -3613	A-5000 -7810
Disc Dia mm	6.0	25.0	18.0	18.0	25.0
Disc depth	1.2	3.0	1.5	2.2	1.5
Roller depth	2.0	NA	2.5	3.0	2.5
Stem dia	2.0	NA	3.0	NA	3.0
Weight	0.6	3.8	3.0	2.7	4.0
					
Price excl VAT	£40.47	£70.00	£67.42	£62.61	£67.42

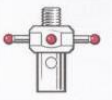
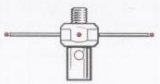
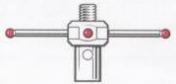
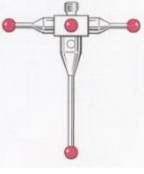
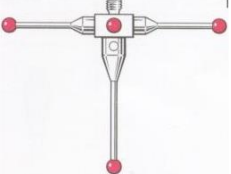
Star Styli (fixed) ~ M2 Thread

Part No.	A-5003 -4011	A-5000 -7811	A-5003 -4787	A-5003 -4788	A-5003 -7629	A-5000 -3626
Span mm	10.0	10.0	20.0	20.0	20.0	30.0
Ball mm	0.5	1.0	0.5	1.0	2.0	2.0
Stem dia mm	0.3	0.7	0.3	0.7	1.4	1.4
EWL mm	NA	NA	NA	NA	12.0	12.0
Weight	0.7	0.5	0.7	0.9	1.3	1.8
						
Price excl VAT	£150.00	£104.34	£155.00	£115.00	£79.51	£76.02

Stylus Centres ~ M2 Thread

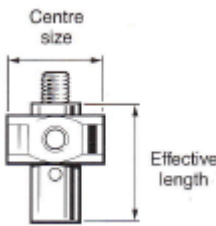
Part No.	A-5000 -8395	A-5000 -3627				
Thread Size	10.0	10.0				
Effective length mm (in)	7.5(0.30)	7.5(0.30)				
Centre offset mm (in)	7.5(0.30)	7.0(0.28)				
Mass grammes	1.1	0.8				
						
Price excl VAT	£44.36	£24.83				







STATUS
Metrology

Status Metrology
Lenton Street
Sandiacre
Nottingham
NG10 5DX

Tel 0115 939 2228
Fax 0115 939 3355
sales@statusmetrology.com
www.statusmetrology.com

Probe Body extension Bars (Aluminium with M8 threads) for touch trigger probes

A family of aluminium extension bars with M8 to M8 threads for use with 2-wire touch-trigger probes (such as TP20) to extend the reach of the CMM.

PEL Series	Part No.	Length	Lightweight Bars	Price excl VAT
PEL1	A-1047-3484	50mm		£105.00
PEL2	A-1047-3485	100mm		£120.00
PEL3	A-1047-3486	200mm		£140.00
PEL4	A-1047-3487	300mm		£155.00
PEL Kit	A-1032-3009	1 x PEL1 1 x PEL2 1 x PEL3		£345.00



STATUS
Metrology

Status Metrology
Lenton Street
Sandiacre
Nottingham
NG10 5DX

Tel 0115 939 2228
Fax 0115 939 3355
sales@statusmetrology.com
www.statusmetrology.com

Datum Balls

Each datum sphere is made from hard wearing tungsten carbide and is supplied with its own certificate, giving ball diameter and roundness. All sphere measurements are performed on equipment traceable to UK (NPL) standards.

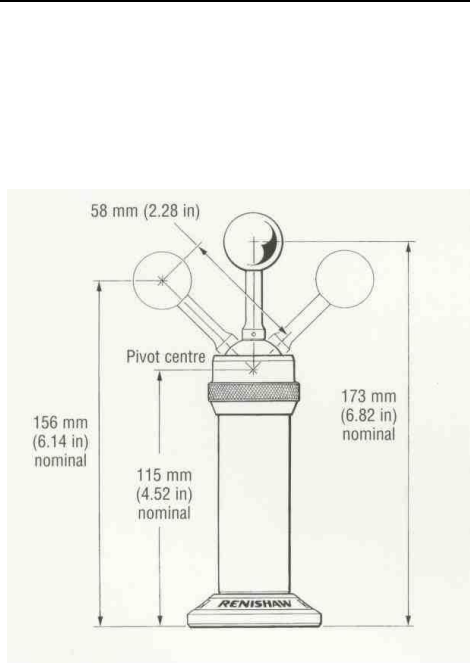

Datum Sphere Kits

	Kit part Number	Price excl VAT
12mm dia Ball	A-1034-0028	£410.00
19mm dia Ball	A-1034-0027	£410.00
25mm dia Ball	A-1034-0026	£440.00
3/4in dia Ball	A-1034-0031	£410.00
1 in dia Ball	A-1034-0035	£440.00

Fixing Stud ~ a fixing stud is required with each kit to attach pillar to table surface

M6 x 1	A-1034-0352	£14.00
M8 x 1.25	A-1034-0351	£13.00
M10 x 1.5	A-1034-0350	£13.00
5/16in x UNC	A-1034-0354	£22.00
3/8 in x UNC	A-1034-0353	£22.00

Optional Extras

12mm dia Datum Ball	A-1034-0005	£140.00
19mm dia Datum Ball	A-1034-0023	£140.00
25mm dia Datum Ball	A-1034-0002	£160.00
3/4 in dia Datum Ball	A-1034-0032	£140.00
1 in dia Datum Ball	A-1034-0036	£160.00

Adaptor/Extensions

2 Way Adaptor	A-1034-0356	£41.00
3 Way Adaptor	A-1034-0357	£120.00
Pillar Extension 75mm long	A-1034-0355	£33.00

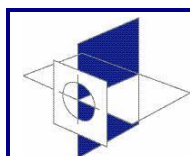

STATUS
Metrology

Status Metrology
Lenton Street
Sandiacre
Nottingham
NG10 5DX

Tel 0115 939 2228
Fax 0115 939 3355
sales@statusmetrology.com
www.statusmetrology.com

Page 16 of 17

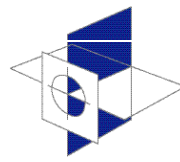

Styli Order Form

FAX TO 0115 939 3355

Company		Contact Name	
Address		Tel. No.	
Post Code		Purchase Order No:	

Part Number	Description	Unit Price	Qty	Total
			Sub Total	
			Total	

Signature:

Date:

Carriage £18.00 standard charge

All prices exclude VAT

Status Metrology Solutions Ltd

Measurement House, Lenton Street

Sandiacre, Nottingham NG10 5DX

Tel: +44(0)115 939 2228

Fax: +44(0)115 939 3355

info@statusmetrology.com

www.statusmetrology.com

Registered No. 2859536

VAT No. 610-690-955