

## CMM STYLI CATALOGUE

### *Pricelist 2017*



**Blank Page**

## Choosing styli for inspection

In the majority of probing applications to maximise accuracy we recommend that you:-

### KEEP STYLI SHORT AND STIFF

The more the stylus bends or deflects, the lower the accuracy. Probing with the minimum stylus length for your application is recommended and where possible the use of one piece styli is suggested. Probing with excessive styli/extension combinations should therefore be avoided.

### KEEP THE STYLUS BALL AS LARGE AS POSSIBLE

This will ensure maximum ball/stem clearance whilst providing a greater yet rigid Effective Working Length (EWL). Using larger ruby balls also reduces the effect of surface finish of the component being inspected.

**Effective working length (EWL)** is the penetration that can be achieved by any ruby ball stylus before its stem fouls against the feature. Generally the larger the ball diameter the greater the EWL (see below).

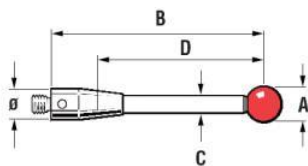

- A Ball diameter
- B Overall length
- C Stem diameter
- D Effective working length
- Ø M2 = 3 mm
- Ø M3 = 4 mm
- Ø M4 = 7 mm
- Ø M5 = 10 mm

## EXPLANATION OF STYLI TYPES

### RUBY BALL STYLI

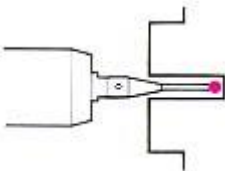

These are suitable for the majority of probing applications. They incorporate highly spherical industrial ruby balls. Ruby is an extremely hard ceramic material and hence wear of stylus balls is minimised. It is also of low density keeping tip mass to a minimum which avoids unwanted probe triggers caused by machine motion or vibration. Ruby balls are available mounted on a variety of materials including non-magnetic stainless steel, ceramic and carbide, to maintain stiffness over the total range of styli.

### STAR STYLI\*

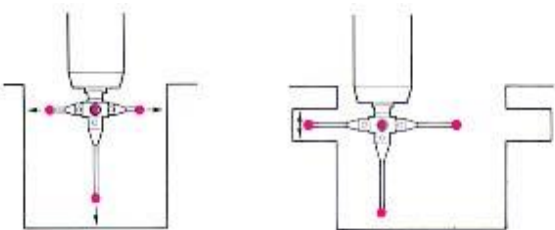

These can be used to inspect a variety of different features.

Using star styli to inspect the extreme points of internal features such as the sides or grooves in a bore, minimises the need to move the probe, due to their multi-tip probing capability.

Each tip on a star stylus requires datuming in the same manner as a single ball stylus.

## POINTER STYLI \*

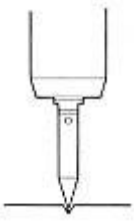

These should not be used for conventional XY Probing. Designed for the measurement of thread forms, specific points and scribed lines (to lower accuracy). The use of radius end pointer styli allows more accurate datuming and probing of features, and can also be used to inspect the location of very small holes.

## CERAMIC HOLLOW BALL STYLUS

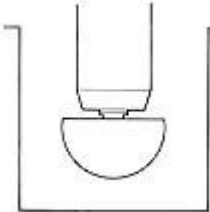

These are ideal for probing deep features and bores in X, Y and Z directions with the need to datum only one ball. In addition, the effects of very rough surfaces can be averaged out by probing with such a large diameter ball.

## DISC STYLUS \*

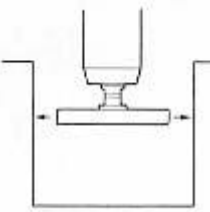

These 'thin sections' of a large sphere are usually used to probe undercuts and grooves. Although probing with the "spherical edge" of a simple disc is effectively the same as probing on or about the equator of a large stylus ball, only a small area of this ball surface is available for contact. Hence thinner discs require careful angular alignment to ensure correct contact of the disc surface with the feature being probed.

A simple disc requires datuming on only one diameter (usually in a ring gauge) but limits effective probing to only X and Y directions.

Adding a radius end roller allows you to datum and hence probe in the Z direction, providing the centre of the 'radius end roller' extends beyond the diameter of the probe.

The radius end roller can be datumed on a sphere or a slip gauge. Rotating and locking the disc about its centre axis allows the 'radius end roller' to be positioned to suit the application.

Disc may also have an M2 threaded centre to allow the fixing of a centre stylus, giving the additional flexibility of probing the bottom of deep bores (where access for the disc may be limited).

## CYLINDER STYLUS

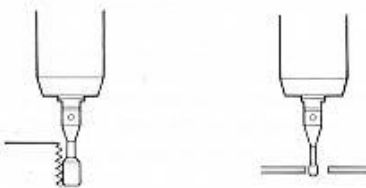

These are used for probing holes in thin sheet material, probing various threaded features and locating the centres of tapped holes.



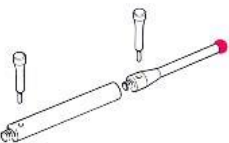

Ball ended cylinder styli allow full datuming and probing in X, Y and Z directions thus allowing surface inspection to be carried out.

## STYLUS EXTENSIONS



These provide added probing penetration by extending the stylus away from the probe. However, using stylus extensions can reduce accuracy due to loss of rigidity.

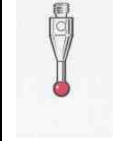
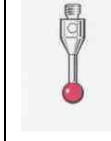
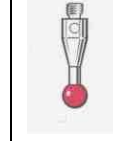
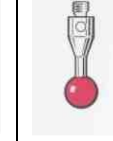
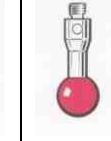
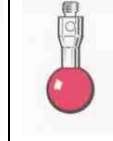

### Ruby Ball Styli (stainless steel stems) 10mm Range ~ M2 Thread

| Part No.       | A-5000<br>-7806                                                                   | A-5000<br>-7802                                                                   | A-5000<br>-7807                                                                   | A-5000<br>-7803                                                                   | A-5000<br>-3604                                                                   | A-5000<br>-4154                                                                    | A-5000<br>-4155                                                                     | A-5000<br>-4156                                                                     | A-5000<br>-4158                                                                     |
|----------------|-----------------------------------------------------------------------------------|-----------------------------------------------------------------------------------|-----------------------------------------------------------------------------------|-----------------------------------------------------------------------------------|-----------------------------------------------------------------------------------|------------------------------------------------------------------------------------|-------------------------------------------------------------------------------------|-------------------------------------------------------------------------------------|-------------------------------------------------------------------------------------|
| A Ball Dia     | 1.0                                                                               | 1.5                                                                               | 2.0                                                                               | 2.5                                                                               | 3.0                                                                               | 4.0                                                                                | 5.0                                                                                 | 6.0                                                                                 | 8.0                                                                                 |
| B Length       | 10.0                                                                              | 10.0                                                                              | 10.0                                                                              | 10.0                                                                              | 10.0                                                                              | 10.0                                                                               | 10.0                                                                                | 10.0                                                                                | 11.0                                                                                |
| C Stem Dia     | 0.7                                                                               | 0.7                                                                               | 1.0                                                                               | 1.0                                                                               | 1.5                                                                               | 1.5                                                                                | 2.5                                                                                 | 2.5                                                                                 | 2.5                                                                                 |
| D EWL          | 4.5                                                                               | 4.5                                                                               | 6.0                                                                               | 6.0                                                                               | 7.5                                                                               | 10.0                                                                               | 10.0                                                                                | 10.0                                                                                | 11.0                                                                                |
| Weight         | 0.3                                                                               | 0.3                                                                               | 0.3                                                                               | 0.3                                                                               | 0.4                                                                               | 0.4                                                                                | 0.7                                                                                 | 0.9                                                                                 | 1.5                                                                                 |
| 10mm range     |  |  |  |  |  |  |  |  |  |
| Price excl VAT | <b>£18.20</b>                                                                     | <b>£14.66</b>                                                                     | <b>£12.73</b>                                                                     | <b>£13.48</b>                                                                     | <b>£14.75</b>                                                                     | <b>£15.52</b>                                                                      | <b>£20.34</b>                                                                       | <b>£22.35</b>                                                                       | <b>£41.61</b>                                                                       |

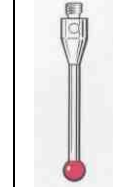
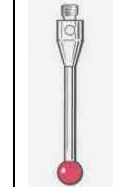
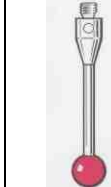
### Ruby Ball Styli (stainless steel stems) 20mm Range ~ M2 Thread

| Part No.       | A-5000<br>-3603                                                                    | A-5000<br>-7804                                                                    | A-5000<br>-4160                                                                    | A-5000<br>-4161                                                                    |
|----------------|------------------------------------------------------------------------------------|------------------------------------------------------------------------------------|------------------------------------------------------------------------------------|------------------------------------------------------------------------------------|
| A Ball Dia     | 2.0                                                                                | 2.5                                                                                | 3.0                                                                                | 4.0                                                                                |
| B Length       | 20.0                                                                               | 20.0                                                                               | 20.0                                                                               | 20.0                                                                               |
| C Stem Dia     | 1.4                                                                                | 1.4                                                                                | 1.5                                                                                | 1.5                                                                                |
| D EWL          | 14.0                                                                               | 14.0                                                                               | 17.5                                                                               | 20.0                                                                               |
| Weight         | 0.4                                                                                | 0.4                                                                                | 0.5                                                                                | 0.6                                                                                |
| 20mm range     |  |  |  |  |
| Price excl VAT | <b>£14.30</b>                                                                      | <b>£14.70</b>                                                                      | <b>£15.44</b>                                                                      | <b>£16.09</b>                                                                      |

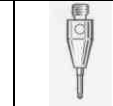
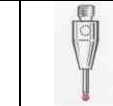
### Ruby Ball Styli (tungsten carbide stems) 10mm Range ~ M2 Thread

| Part No.       | A-5000<br>-7800                                                                     | A-5000<br>-7805                                                                     | A-5000<br>-7801                                                                     | A-5003<br>-1325                                                                     |
|----------------|-------------------------------------------------------------------------------------|-------------------------------------------------------------------------------------|-------------------------------------------------------------------------------------|-------------------------------------------------------------------------------------|
| A Ball Dia     | 0.3                                                                                 | 0.5                                                                                 | 0.7                                                                                 | 1.0                                                                                 |
| B Length       | 10.0                                                                                | 10.0                                                                                | 10.0                                                                                | 10.0                                                                                |
| C Stem Dia     | 0.2                                                                                 | 0.4                                                                                 | 0.5                                                                                 | 0.7                                                                                 |
| D EWL          | 2.0                                                                                 | 3.0                                                                                 | 4.0                                                                                 | 2.0                                                                                 |
| Weight         | 0.3                                                                                 | 0.3                                                                                 | 0.3                                                                                 | 0.3                                                                                 |
| 10mm range     |  |  |  |  |
| Price excl VAT | <b>£76.00</b>                                                                       | <b>£75.94</b>                                                                       | <b>£63.41</b>                                                                       | <b>£40.00</b>                                                                       |



**STATUS**  
Metrology





Status Metrology  
Lenton Street  
Sandiacre  
Nottingham  
NG10 5DX

Tel 0115 939 2228  
Fax 0115 939 3355





[sales@statusmetrology.com](mailto:sales@statusmetrology.com)  
[www.statusmetrology.com](http://www.statusmetrology.com)

Page 5 of 17

### Ruby Ball Styli (tungsten carbide stems) 20mm Range ~ M2 Thread

| Part No.       | A-5003<br>-1345                                                                   | A-5003<br>-0577                                                                   | A-5000<br>-7808                                                                   | A-5003<br>-0033                                                                   | A-5003<br>-0034                                                                   |
|----------------|-----------------------------------------------------------------------------------|-----------------------------------------------------------------------------------|-----------------------------------------------------------------------------------|-----------------------------------------------------------------------------------|-----------------------------------------------------------------------------------|
| A Ball Dia     | 0.5                                                                               | 0.7                                                                               | 1.0                                                                               | 1.0                                                                               | 1.5                                                                               |
| B Length       | 20.0                                                                              | 20.0                                                                              | 20.0                                                                              | 20.0                                                                              | 20.0                                                                              |
| C Stem Dia     | 0.3                                                                               | 0.5                                                                               | 0.7                                                                               | 0.8                                                                               | 1.0                                                                               |
| D EWL          | 7.0                                                                               | 12.0                                                                              | 7.0                                                                               | 12.5                                                                              | 12.5                                                                              |
| Weight         | 0.48                                                                              | 0.32                                                                              | 0.5                                                                               | 0.41                                                                              | 0.5                                                                               |
| 20mm range     |  |  |  |  |  |
| Price excl VAT | <b>£80.00</b>                                                                     | <b>£67.0</b>                                                                      | <b>£30.39</b>                                                                     | <b>£37.35</b>                                                                     | <b>£37.35</b>                                                                     |

### Ruby Ball Styli (tungsten carbide stems) 20mm Range ~ M2 Thread cont'd

| Part No.       | A-5003<br>-3822                                                                    | A-5003<br>-1896                                                                    | A-5003<br>-0938                                                                    | A-5003<br>-1029                                                                    | A-5003<br>-0046                                                                    |
|----------------|------------------------------------------------------------------------------------|------------------------------------------------------------------------------------|------------------------------------------------------------------------------------|------------------------------------------------------------------------------------|------------------------------------------------------------------------------------|
| A Ball Dia     | 2.0                                                                                | 2.5                                                                                | 3.0                                                                                | 4.0                                                                                | 5.0                                                                                |
| B Length       | 20.0                                                                               | 20.0                                                                               | 20.0                                                                               | 20.0                                                                               | 20.0                                                                               |
| C Stem Dia     | 1.0                                                                                | 1.0                                                                                | 1.5                                                                                | 2.0                                                                                | 2.5                                                                                |
| D EWL          | 12.0                                                                               | 15.5                                                                               | 20.0                                                                               | 22.0                                                                               | 20.0                                                                               |
| Weight         | 0.48                                                                               | 0.5                                                                                | 0.77                                                                               | 1.24                                                                               | 1.98                                                                               |
| 20mm range     |  |  |  |  |  |
| Price excl VAT | <b>£37.35</b>                                                                      | <b>£37.35</b>                                                                      | <b>£40.85</b>                                                                      | <b>£40.85</b>                                                                      | <b>£40.85</b>                                                                      |

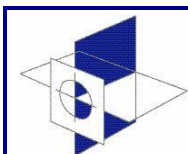







**STATUS**  
Metrology

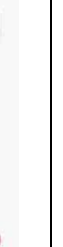

Status Metrology  
Lenton Street  
Sandiacre  
Nottingham  
NG10 5DX

Tel 0115 939 2228  
Fax 0115 939 3355  
[sales@statusmetrology.com](mailto:sales@statusmetrology.com)  
[www.statusmetrology.com](http://www.statusmetrology.com)



### Ruby Ball Styli (tungsten carbide stems) 30mm Range ~ M2 Thread

| Part No.       | A-5000<br>-8663                                                                   | A-5003<br>-0035                                                                   | A-5003<br>-0036                                                                   | A-5003<br>-0038                                                                   | A-5003<br>-0040                                                                    | A-5003<br>-0043                                                                     | A-5003<br>-0047                                                                     |
|----------------|-----------------------------------------------------------------------------------|-----------------------------------------------------------------------------------|-----------------------------------------------------------------------------------|-----------------------------------------------------------------------------------|------------------------------------------------------------------------------------|-------------------------------------------------------------------------------------|-------------------------------------------------------------------------------------|
| A Ball Dia     | 1.0                                                                               | 1.5                                                                               | 2.0                                                                               | 2.5                                                                               | 3.0                                                                                | 4.0                                                                                 | 5.0                                                                                 |
| B Length       | 27.0                                                                              | 30.0                                                                              | 30.0                                                                              | 30.0                                                                              | 30.0                                                                               | 30.0                                                                                | 30.0                                                                                |
| C Stem Dia     | 0.7                                                                               | 1.0                                                                               | 1.5                                                                               | 2.0                                                                               | 2.0                                                                                | 2.0                                                                                 | 2.5                                                                                 |
| D EWL          | 20.5                                                                              | 22.5                                                                              | 22.5                                                                              | 25.0                                                                              | 25.0                                                                               | 30.0                                                                                | 30.0                                                                                |
| Weight         | 0.40                                                                              | 0.58                                                                              | 0.99                                                                              | 1.48                                                                              | 1.49                                                                               | 1.57                                                                                | 2.57                                                                                |
| 30mm range     |  |  |  |  |  |  |  |
| Price excl VAT | £49.03                                                                            | £40.85                                                                            | £37.35                                                                            | £37.35                                                                            | £40.85                                                                             | £40.85                                                                              | £40.85                                                                              |

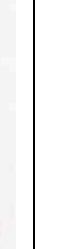
### Ruby Ball Styli (ceramic stems) 30mm Range ~ M2 Thread cont'd

| Part No.       | A-5003<br>-4177                                                                     | A-5003<br>-1370                                                                     | A-5003<br>-4779                                                                     | A-5003<br>-4780                                                                     |
|----------------|-------------------------------------------------------------------------------------|-------------------------------------------------------------------------------------|-------------------------------------------------------------------------------------|-------------------------------------------------------------------------------------|
| A Ball Dia     | 3.0                                                                                 | 4.0                                                                                 | 5.0                                                                                 | 6.0                                                                                 |
| B Length       | 30.0                                                                                | 30.0                                                                                | 30.0                                                                                | 30.0                                                                                |
| C Stem Dia     | 2.0                                                                                 | 2.0                                                                                 | 2.5                                                                                 | 2.5                                                                                 |
| D EWL          | 27.5                                                                                | 30.0                                                                                | 30.0                                                                                | 30.0                                                                                |
| Weight         | 0.44                                                                                | 0.68                                                                                | 0.93                                                                                | 1.11                                                                                |
| 30mm range     |  |  |  |  |
| Price excl VAT | £50.00                                                                              | £55.00                                                                              | £45.00                                                                              | £47.86                                                                              |

### Ruby Ball Styli (carbon fibre stems) 30mm Range ~ M2 Thread cont'd

| Part No.       | A-5003<br>-4241                                                                     | A-5003<br>-4781                                                                     | A-5003<br>-4782                                                                     |
|----------------|-------------------------------------------------------------------------------------|-------------------------------------------------------------------------------------|-------------------------------------------------------------------------------------|
| A Ball Dia     | 4.0                                                                                 | 5.0                                                                                 | 6.0                                                                                 |
| B Length       | 30.0                                                                                | 30.0                                                                                | 30.0                                                                                |
| C Stem Dia     | 2.0                                                                                 | 3.0                                                                                 | 3.0                                                                                 |
| D EWL          | 30.0                                                                                | 30.0                                                                                | 30.0                                                                                |
| Weight         | 0.57                                                                                | 0.79                                                                                | 0.96                                                                                |
| 30mm range     |  |  |  |
| Price excl VAT | £52.00                                                                              | £54.00                                                                              | £57.00                                                                              |

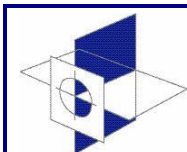









**STATUS**  
Metrology

Status Metrology  
Lenton Street  
Sandiacre  
Nottingham  
NG10 5DX

Tel 0115 939 2228  
Fax 0115 939 3355  
[sales@statusmetrology.com](mailto:sales@statusmetrology.com)  
[www.statusmetrology.com](http://www.statusmetrology.com)

## Ruby Ball Styli (tungsten carbide stems) 40mm & 50mm Range ~ M2 Thread

| Part No.                      | A-5003<br>-0037                                                                   | A-5003<br>-0039                                                                   | A-5003<br>-0041                                                                   | A-5003<br>-0044                                                                   | A-5003<br>-0048                                                                    | A-5003<br>-0042                                                                      | A-5003<br>-0045                                                                      | A-5003<br>-0049                                                                      |
|-------------------------------|-----------------------------------------------------------------------------------|-----------------------------------------------------------------------------------|-----------------------------------------------------------------------------------|-----------------------------------------------------------------------------------|------------------------------------------------------------------------------------|--------------------------------------------------------------------------------------|--------------------------------------------------------------------------------------|--------------------------------------------------------------------------------------|
| <b>A</b> Ball Dia             | 2.0                                                                               | 2.5                                                                               | 3.0                                                                               | 4.0                                                                               | 5.0                                                                                | 3.0                                                                                  | 4.0                                                                                  | 5.0                                                                                  |
| <b>B</b> Length               | 40.0                                                                              | 40.0                                                                              | 40.0                                                                              | 40.0                                                                              | 40.0                                                                               | 50.0                                                                                 | 50.0                                                                                 | 50.0                                                                                 |
| <b>C</b> Stem Dia             | 1.5                                                                               | 2.0                                                                               | 2.0                                                                               | 2.0                                                                               | 2.5                                                                                | 2.0                                                                                  | 2.0                                                                                  | 2.5                                                                                  |
| <b>D</b> EWL                  | 32.5                                                                              | 32.5                                                                              | 37.0                                                                              | 40.0                                                                              | 40.0                                                                               | 47.0                                                                                 | 50.0                                                                                 | 50.0                                                                                 |
| Weight                        | 1.29                                                                              | 1.95                                                                              | 1.97                                                                              | 2.04                                                                              | 3.17                                                                               | 2.44                                                                                 | 2.52                                                                                 | 3.75                                                                                 |
| 40mm range<br>&<br>50mm range |  |  |  |  |  |  |  |  |
| Price excl VAT                | <b>£40.85</b>                                                                     | <b>£40.85</b>                                                                     | <b>£43.78</b>                                                                     | <b>£43.78</b>                                                                     | <b>£43.78</b>                                                                      | <b>£43.78</b>                                                                        | <b>£43.78</b>                                                                        | <b>£43.78</b>                                                                        |

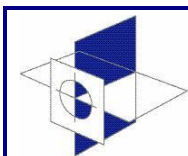

STATUS

Metrology

**Status Metrology**  
Lenton Street  
Sandiacre  
Nottingham  
NG10 5DX

Tel 0115 939 2228  
Fax 0115 939 3355  
[sales@statusmetrology.com](mailto:sales@statusmetrology.com)  
[www.statusmetrology.com](http://www.statusmetrology.com)

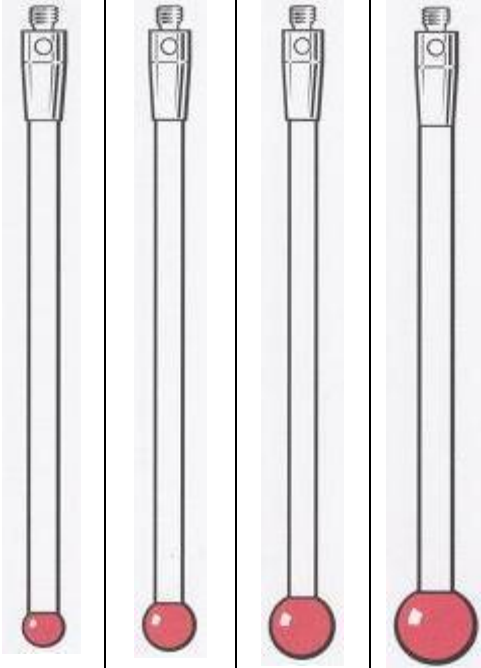

### Ruby Ball Styli (ceramic stems) 50mm Range ~ M2 Thread cont'd

| Part No.       | A-5003<br>-0064                                                                    | A-5003<br>-0065 | A-5003<br>-0066 | A-5003<br>-0470 |
|----------------|------------------------------------------------------------------------------------|-----------------|-----------------|-----------------|
| A Ball Dia     | 3.0                                                                                | 4.0             | 5.0             | 6.0             |
| B Length       | 50.0                                                                               | 50.0            | 50.0            | 50.0            |
| C Stem Dia     | 2.0                                                                                | 2.0             | 2.5             | 2.5             |
| D EWL          | 47.0                                                                               | 50.0            | 50.0            | 50.0            |
| Weight         | 0.83                                                                               | 0.91            | 1.31            | 1.49            |
| 50mm range     |  |                 |                 |                 |
| Price excl VAT | £47.86                                                                             | £47.86          | £47.86          | £45.00          |

### Ruby Ball Styli (carbon fibre stems) 50mm Range ~ M2 Thread cont'd

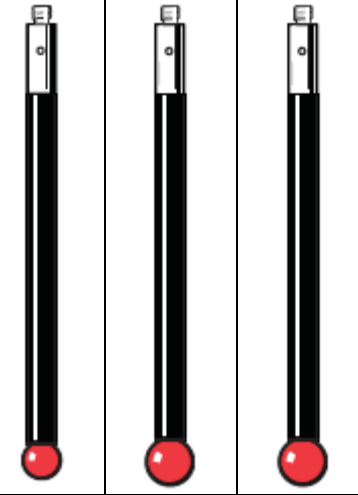
| Part No.       | A-5003<br>-2285                                                                     | A-5003<br>-2286 | A-5003<br>-2287 |
|----------------|-------------------------------------------------------------------------------------|-----------------|-----------------|
| A Ball Dia     | 4.0                                                                                 | 5.0             | 6.0             |
| B Length       | 50.0                                                                                | 50.0            | 50.0            |
| C Stem Dia     | 3.0                                                                                 | 3.0             | 3.0             |
| D EWL          | 50.0                                                                                | 50.0            | 50.0            |
| Weight         | 1.00                                                                                | 1.10            | 1.20            |
| 50mm range     |  |                 |                 |
| Price excl VAT | £57.84                                                                              | £59.98          | £62.12          |

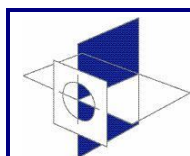

**STATUS**  
Metrology

Status Metrology  
Lenton Street  
Sandiacre  
Nottingham  
NG10 5DX

Tel 0115 939 2228  
Fax 0115 939 3355  
[sales@statusmetrology.com](mailto:sales@statusmetrology.com)  
[www.statusmetrology.com](http://www.statusmetrology.com)

**Ruby Ball Styli (carbon fibre stems) 75mm Range ~ M2 Thread cont'd**

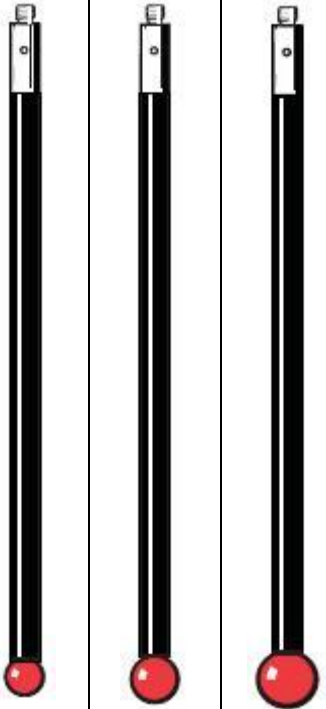
| Part No.       | A-5003<br>-4784                                                                    | A-5003<br>-4785 | A-5003<br>-4786 |
|----------------|------------------------------------------------------------------------------------|-----------------|-----------------|
| A Ball Dia     | 4.0                                                                                | 5.0             | 6.0             |
| B Length       | 75.0                                                                               | 75.0            | 75.0            |
| C Stem Dia     | 3.0                                                                                | 3.0             | 3.0             |
| D EWL          | 75.0                                                                               | 75.0            | 75.0            |
| Weight         | 1.15                                                                               | 1.27            | 1.45            |
| 75mm range     |  |                 |                 |
| Price excl VAT | <b>£70.50</b>                                                                      | <b>£75.00</b>   | <b>£79.50</b>   |

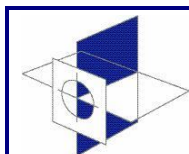

**STATUS**  
Metrology

**Status Metrology**  
Lenton Street  
Sandiacre  
Nottingham  
NG10 5DX

Tel 0115 939 2228  
Fax 0115 939 3355  
[sales@statusmetrology.com](mailto:sales@statusmetrology.com)  
[www.statusmetrology.com](http://www.statusmetrology.com)

**Ruby Ball Styli (carbon fibre stems) 100mm Range ~ M2 Thread cont'd**

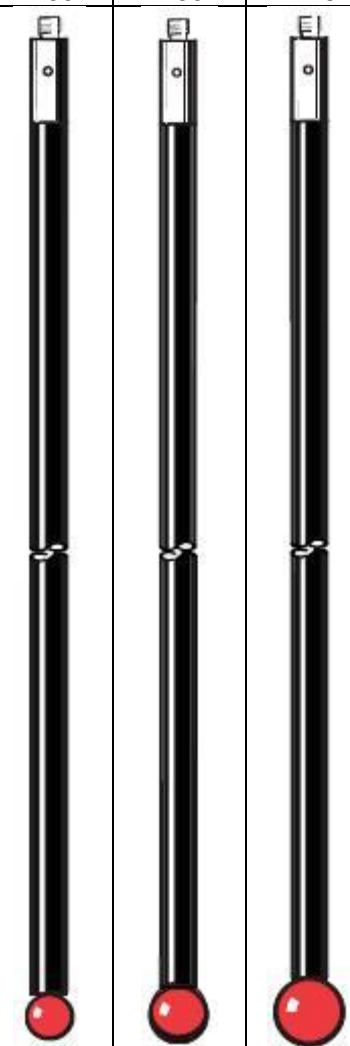
| Part No.       | A-5003<br>-2289                                                                    | A-5003<br>-2290 | A-5003<br>-2291 |
|----------------|------------------------------------------------------------------------------------|-----------------|-----------------|
| A Ball Dia     | 4.0                                                                                | 5.0             | 6.0             |
| B Length       | 100.0                                                                              | 100.0           | 100.0           |
| C Stem Dia     | 3.0                                                                                | 3.0             | 3.0             |
| D EWL          | 100.0                                                                              | 100.0           | 100.0           |
| Weight         | 1.50                                                                               | 1.59            | 1.78            |
| 100mm<br>range |  |                 |                 |
| Price excl VAT | <b>£80.50</b>                                                                      | <b>£85.00</b>   | <b>£89.50</b>   |

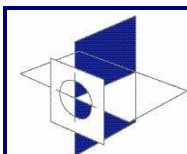





**STATUS**  
Metrology

Status Metrology  
Lenton Street  
Sandiacre  
Nottingham  
NG10 5DX

Tel 0115 939 2228  
Fax 0115 939 3355  
[sales@statusmetrology.com](mailto:sales@statusmetrology.com)  
[www.statusmetrology.com](http://www.statusmetrology.com)

**Stylus Extensions (carbon fibre stems) ~ M2 Thread cont'd**

| Part No.            | A-5003<br>-2280                                                                   | A-5003<br>-2281                                                                   | A-5003<br>-2282                                                                   | A-5003<br>-2283                                                                    |
|---------------------|-----------------------------------------------------------------------------------|-----------------------------------------------------------------------------------|-----------------------------------------------------------------------------------|------------------------------------------------------------------------------------|
| Length              | 40.0                                                                              | 50.0                                                                              | 70.0                                                                              | 90.0                                                                               |
| Stem Dia            | 3.0                                                                               | 3.0                                                                               | 3.0                                                                               | 3.0                                                                                |
| Outer Dia           | 3.5                                                                               | 3.5                                                                               | 3.5                                                                               | 3.5                                                                                |
| Weight              | 0.9                                                                               | 1.0                                                                               | 1.3                                                                               | 1.5                                                                                |
| 75 - 100mm<br>range |  |  |  |  |
| Price excl VAT      | <b>£53.54</b>                                                                     | <b>£55.69</b>                                                                     | <b>£57.84</b>                                                                     | <b>£59.98</b>                                                                      |

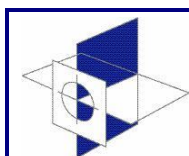







**STATUS**  
Metrology





Status Metrology  
Lenton Street  
Sandiacre  
Nottingham  
NG10 5DX

Tel 0115 939 2228  
Fax 0115 939 3355  
[sales@statusmetrology.com](mailto:sales@statusmetrology.com)  
[www.statusmetrology.com](http://www.statusmetrology.com)







### Cylinder Ball Styli (stainless steel stems) ~ M2 Thread

| Part No.       | A-5004<br>-7589                                                                   | A-5004<br>-7590                                                                   | A-5000<br>-8876                                                                   | A-5000<br>-8877                                                                   | A-5000<br>-7812                                                                   | A-5000<br>-0073                                                                     |
|----------------|-----------------------------------------------------------------------------------|-----------------------------------------------------------------------------------|-----------------------------------------------------------------------------------|-----------------------------------------------------------------------------------|-----------------------------------------------------------------------------------|-------------------------------------------------------------------------------------|
| A Ball Dia     | 1.5                                                                               | 3.0                                                                               | 1.0                                                                               | 1.5                                                                               | 2.0                                                                               | 4.0                                                                                 |
| B Length       | 11.0                                                                              | 13.0                                                                              | 15.0                                                                              | 15.0                                                                              | 20.0                                                                              | 20.0                                                                                |
| C Stem Dia     | 1.0                                                                               | 1.5                                                                               | NA                                                                                | NA                                                                                | 1.6                                                                               | 2.0                                                                                 |
| D EWL          | 1.5                                                                               | 3.8                                                                               | 8.0                                                                               | 8.0                                                                               | 7.2                                                                               | 10.0                                                                                |
| Weight         | 0.3                                                                               | 0.6                                                                               | 0.3                                                                               | 0.3                                                                               | 0.5                                                                               | 0.9                                                                                 |
| 10mm range     |  |  |  |  |  |  |
| Price excl VAT | £11.18                                                                            | £11.18                                                                            | £158.27                                                                           | £138.93                                                                           | £104.34                                                                           | £127.26                                                                             |

### Stylus extensions (stainless steel stems) ~ M2 Thread

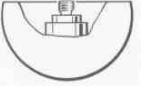
| Part No.       | A-5004<br>-7610                                                                   | A-5004<br>-7585                                                                   | A-5004<br>-7586                                                                    | A-5004<br>-7591                                                                    | A-5004<br>-7611                                                                    |
|----------------|-----------------------------------------------------------------------------------|-----------------------------------------------------------------------------------|------------------------------------------------------------------------------------|------------------------------------------------------------------------------------|------------------------------------------------------------------------------------|
| Length         | 5.0                                                                               | 10.0                                                                              | 20.0                                                                               | 30.0                                                                               | 40.0                                                                               |
| Stem Dia       | 3.0                                                                               | 3.0                                                                               | 3.0                                                                                | 3.0                                                                                | 3.0                                                                                |
| Weight         | 0.2                                                                               | 0.4                                                                               | 0.9                                                                                | 1.4                                                                                | 1.8                                                                                |
|                |  |  |  |  |  |
| Price excl VAT | £6.24                                                                             | £7.30                                                                             | £7.99                                                                              | £9.04                                                                              | £9.80                                                                              |

### Special purpose styli ~ M2 Thread

| Part No.       | A-5004<br>-7588<br>Silver steel                                                     | A-5000<br>-7813<br>Tungsten<br>carbide                                              | A-5000<br>-3614<br>Ceramic                                                          | A-5000<br>-7534<br>M2<br>Knuckle                                                    | A-5004<br>-7593<br>M2/M3<br>adaptor                                                   | A-5004<br>-7592<br>M3/M2<br>adaptor                                                   |
|----------------|-------------------------------------------------------------------------------------|-------------------------------------------------------------------------------------|-------------------------------------------------------------------------------------|-------------------------------------------------------------------------------------|---------------------------------------------------------------------------------------|---------------------------------------------------------------------------------------|
| Length mm      | 15.0                                                                                | 10.0                                                                                | 11.0                                                                                | 8.0                                                                                 | 7.0                                                                                   | 5.0                                                                                   |
| Ball dia mm    | NA                                                                                  | NA                                                                                  | 18.0                                                                                | NA                                                                                  | NA                                                                                    | NA                                                                                    |
| End feature mm | Flat Rad 0.05                                                                       | Flat Rad 0.05                                                                       | NA                                                                                  | NA                                                                                  | NA                                                                                    | NA                                                                                    |
| Weight         | 0.7                                                                                 | 0.7                                                                                 | 3.3                                                                                 | 1.6                                                                                 | 0.6                                                                                   | 1.5                                                                                   |
| Angles         | 30 inclusive                                                                        | 30 inclusive                                                                        | NA                                                                                  | NA                                                                                  |                                                                                       |                                                                                       |
|                |  |  |  |  |  |  |
| Price excl VAT | £14.51                                                                              | £50.80                                                                              | £160.03                                                                             | £33.63                                                                              | £6.86                                                                                 | £6.00                                                                                 |

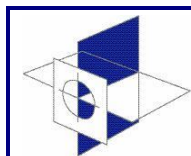





**STATUS**  
Metrology

Status Metrology  
Lenton Street  
Sandiacre  
Nottingham  
NG10 5DX

Tel 0115 939 2228  
Fax 0115 939 3355  
[sales@statusmetrology.com](mailto:sales@statusmetrology.com)  
[www.statusmetrology.com](http://www.statusmetrology.com)

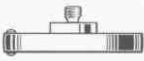

### Stylus extensions (stainless steel stems) ~ M2 Thread

| Part No.       | A-5000<br>-3611                                                                   | A-5000<br>-4187                                                                   | A-5000<br>-7809                                                                   | A-5000<br>-3613                                                                    | A-5000<br>-7810                                                                     |
|----------------|-----------------------------------------------------------------------------------|-----------------------------------------------------------------------------------|-----------------------------------------------------------------------------------|------------------------------------------------------------------------------------|-------------------------------------------------------------------------------------|
| Disc Dia mm    | 6.0                                                                               | 25.0                                                                              | 18.0                                                                              | 18.0                                                                               | 25.0                                                                                |
| Disc depth     | 1.2                                                                               | 3.0                                                                               | 1.5                                                                               | 2.2                                                                                | 1.5                                                                                 |
| Roller depth   | 2.0                                                                               | NA                                                                                | 2.5                                                                               | 3.0                                                                                | 2.5                                                                                 |
| Stem dia       | 2.0                                                                               | NA                                                                                | 3.0                                                                               | NA                                                                                 | 3.0                                                                                 |
| Weight         | 0.6                                                                               | 3.8                                                                               | 3.0                                                                               | 2.7                                                                                | 4.0                                                                                 |
|                |  |  |  |  |  |
| Price excl VAT | <b>£40.47</b>                                                                     | <b>£70.00</b>                                                                     | <b>£67.42</b>                                                                     | <b>£62.61</b>                                                                      | <b>£67.42</b>                                                                       |

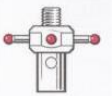
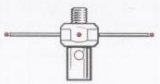
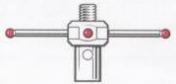
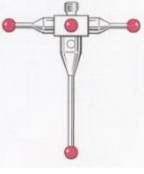
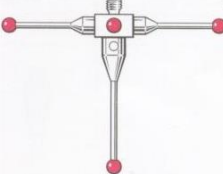
### Star Styli (fixed) ~ M2 Thread

| Part No.       | A-5003<br>-4011                                                                   | A-5000<br>-7811                                                                   | A-5003<br>-4787                                                                   | A-5003<br>-4788                                                                   | A-5003<br>-7629                                                                      | A-5000<br>-3626                                                                      |
|----------------|-----------------------------------------------------------------------------------|-----------------------------------------------------------------------------------|-----------------------------------------------------------------------------------|-----------------------------------------------------------------------------------|--------------------------------------------------------------------------------------|--------------------------------------------------------------------------------------|
| Span mm        | 10.0                                                                              | 10.0                                                                              | 20.0                                                                              | 20.0                                                                              | 20.0                                                                                 | 30.0                                                                                 |
| Ball mm        | 0.5                                                                               | 1.0                                                                               | 0.5                                                                               | 1.0                                                                               | 2.0                                                                                  | 2.0                                                                                  |
| Stem dia mm    | 0.3                                                                               | 0.7                                                                               | 0.3                                                                               | 0.7                                                                               | 1.4                                                                                  | 1.4                                                                                  |
| EWL mm         | NA                                                                                | NA                                                                                | NA                                                                                | NA                                                                                | 12.0                                                                                 | 12.0                                                                                 |
| Weight         | 0.7                                                                               | 0.5                                                                               | 0.7                                                                               | 0.9                                                                               | 1.3                                                                                  | 1.8                                                                                  |
|                |  |  |  |  |  |  |
| Price excl VAT | <b>£150.00</b>                                                                    | <b>£104.34</b>                                                                    | <b>£155.00</b>                                                                    | <b>£115.00</b>                                                                    | <b>£79.51</b>                                                                        | <b>£76.02</b>                                                                        |

### Stylus Centres ~ M2 Thread

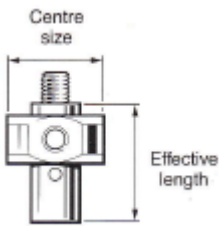
| Part No.                 | A-5000<br>-8395                                                                     | A-5000<br>-3627                                                                     |                                                                                      |  |  |  |
|--------------------------|-------------------------------------------------------------------------------------|-------------------------------------------------------------------------------------|--------------------------------------------------------------------------------------|--|--|--|
| Thread Size              | 10.0                                                                                | 10.0                                                                                |                                                                                      |  |  |  |
| Effective length mm (in) | 7.5(0.30)                                                                           | 7.5(0.30)                                                                           |                                                                                      |  |  |  |
| Centre offset mm (in)    | 7.5(0.30)                                                                           | 7.0(0.28)                                                                           |                                                                                      |  |  |  |
| Mass grammes             | 1.1                                                                                 | 0.8                                                                                 |                                                                                      |  |  |  |
|                          |  |  |  |  |  |  |
| Price excl VAT           | <b>£44.36</b>                                                                       | <b>£24.83</b>                                                                       |                                                                                      |  |  |  |

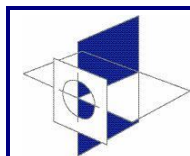





**STATUS**  
Metrology

Status Metrology  
Lenton Street  
Sandiacre  
Nottingham  
NG10 5DX

Tel 0115 939 2228  
Fax 0115 939 3355  
[sales@statusmetrology.com](mailto:sales@statusmetrology.com)  
[www.statusmetrology.com](http://www.statusmetrology.com)

### Probe Body extension Bars (Aluminium with M8 threads) for touch trigger probes

A family of aluminium extension bars with M8 to M8 threads for use with 2-wire touch-trigger probes (such as TP20) to extend the reach of the CMM.

| PEL Series | Part No.    | Length                           | Lightweight Bars                                                                   | Price excl VAT |
|------------|-------------|----------------------------------|------------------------------------------------------------------------------------|----------------|
| PEL1       | A-1047-3484 | 50mm                             |   | £105.00        |
| PEL2       | A-1047-3485 | 100mm                            |   | £120.00        |
| PEL3       | A-1047-3486 | 200mm                            |  | £140.00        |
| PEL4       | A-1047-3487 | 300mm                            |  | £155.00        |
| PEL Kit    | A-1032-3009 | 1 x PEL1<br>1 x PEL2<br>1 x PEL3 |                                                                                    | £345.00        |

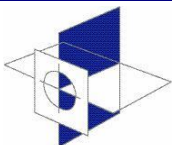

**STATUS**  
Metrology

Status Metrology  
Lenton Street  
Sandiacre  
Nottingham  
NG10 5DX

Tel 0115 939 2228  
Fax 0115 939 3355  
[sales@statusmetrology.com](mailto:sales@statusmetrology.com)  
[www.statusmetrology.com](http://www.statusmetrology.com)

## Datum Balls

Each datum sphere is made from hard wearing tungsten carbide and is supplied with its own certificate, giving ball diameter and roundness. All sphere measurements are performed on equipment traceable to UK (NPL) standards.

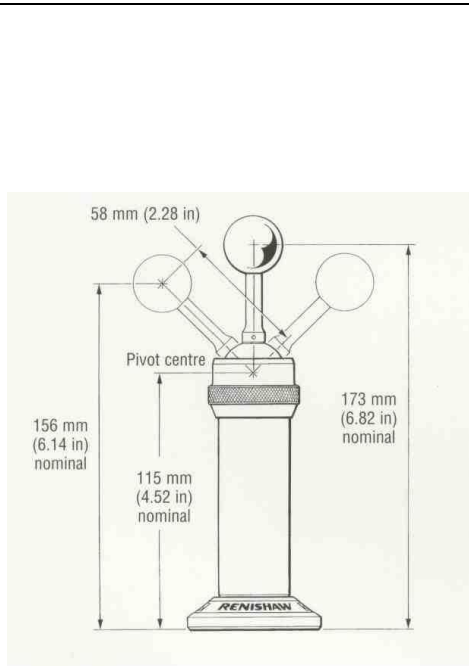

### Datum Sphere Kits

|                | Kit part Number | Price excl VAT |
|----------------|-----------------|----------------|
| 12mm dia Ball  | A-1034-0028     | £410.00        |
| 19mm dia Ball  | A-1034-0027     | £410.00        |
| 25mm dia Ball  | A-1034-0026     | £440.00        |
| 3/4in dia Ball | A-1034-0031     | £410.00        |
| 1 in dia Ball  | A-1034-0035     | £440.00        |

### Fixing Stud ~ a fixing stud is required with each kit to attach pillar to table surface

|              |             |        |
|--------------|-------------|--------|
| M6 x 1       | A-1034-0352 | £14.00 |
| M8 x 1.25    | A-1034-0351 | £13.00 |
| M10 x 1.5    | A-1034-0350 | £13.00 |
| 5/16in x UNC | A-1034-0354 | £22.00 |
| 3/8 in x UNC | A-1034-0353 | £22.00 |

### Optional Extras

|                       |             |         |
|-----------------------|-------------|---------|
| 12mm dia Datum Ball   | A-1034-0005 | £140.00 |
| 19mm dia Datum Ball   | A-1034-0023 | £140.00 |
| 25mm dia Datum Ball   | A-1034-0002 | £160.00 |
| 3/4 in dia Datum Ball | A-1034-0032 | £140.00 |
| 1 in dia Datum Ball   | A-1034-0036 | £160.00 |

### Adaptor/Extensions

|                               |             |         |
|-------------------------------|-------------|---------|
| 2 Way Adaptor                 | A-1034-0356 | £41.00  |
| 3 Way Adaptor                 | A-1034-0357 | £120.00 |
| Pillar Extension<br>75mm long | A-1034-0355 | £33.00  |

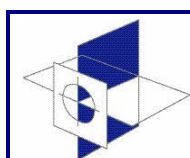

**STATUS**  
Metrology

Status Metrology  
Lenton Street  
Sandiacre  
Nottingham  
NG10 5DX

Tel 0115 939 2228  
Fax 0115 939 3355  
[sales@statusmetrology.com](mailto:sales@statusmetrology.com)  
[www.statusmetrology.com](http://www.statusmetrology.com)

Page 16 of 17



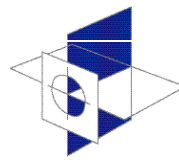

## Styli Order Form

**FAX TO 0115 939 3355**

|           |  |                    |  |
|-----------|--|--------------------|--|
| Company   |  | Contact Name       |  |
| Address   |  | Tel. No.           |  |
|           |  |                    |  |
| Post Code |  | Purchase Order No: |  |

| Part Number      | Description | Unit Price | Qty | Total |
|------------------|-------------|------------|-----|-------|
|                  |             |            |     |       |
|                  |             |            |     |       |
|                  |             |            |     |       |
|                  |             |            |     |       |
|                  |             |            |     |       |
|                  |             |            |     |       |
|                  |             |            |     |       |
|                  |             |            |     |       |
|                  |             |            |     |       |
|                  |             |            |     |       |
|                  |             |            |     |       |
| <b>Sub Total</b> |             |            |     |       |
| <b>Total</b>     |             |            |     |       |

Signature: \_\_\_\_\_

Date: \_\_\_\_\_

|                                                          |
|----------------------------------------------------------|
| A minimum order value of £50 applies, plus £15 P&P       |
| On orders over £100 P&P is FREE (All prices exclude VAT) |

**Status Metrology Solutions Ltd**  
 Measurement House, Lenton Street  
 Sandiacre, Nottingham NG10 5DX  
 Tel: +44(0)115 939 2228      Fax: +44(0)115 939 3355  
 info@statusmetrology.com      www.statusmetrology.com  
 Registered No. 2859536      VAT No. 610-690-955